

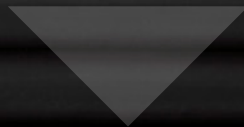

FITTINGS CATALOGUE

CODAN RUBBER DANMARK A/S



Codan 45° female O-ring step up - step down

- 45° FEMALE O-RING step up - step down
- 45° FEMALE O-RING
- 45° FEMALE SERVICE O-RING
- 45° MALE O-RING INSERT
- 45° MALE O-RING step up - step down
- 45° MALE O-RING
- 90° FEMALE O-RING step up - step down
- 90° FEMALE O-RING
- 90° FEMALE SERVICE O-RING
- 90° FEMALE SHORT O-RING
- 90° MALE O-RING INSERT
- 90° MALE O-RING step up - step down
- 90° MALE O-RING
- 180° FEMALE O-RING
- REUSEABLE 45° FLANGE FEMALE FITTING
- REUSEABLE 90° FEMALE FITTING
- REUSEABLE 90° FLANGE FEMALE FITTING
- REUSEABLE STRAIGHT FLANGE FEMALE FITTING
- SPLICER STRAIGHT SERVICE O-RING
- STRAIGHT FEMALE O-RING step up - step down
- STRAIGHT FEMALE O-RING
- STRAIGHT MALE O-RING INSERT
- STRAIGHT MALE O-RING step up - step down
- STRAIGHT MALE O-RING
- STRAIGHT SERVICE FEMALE O-RING
- STRAIGHT SERVICE MALE O-RING

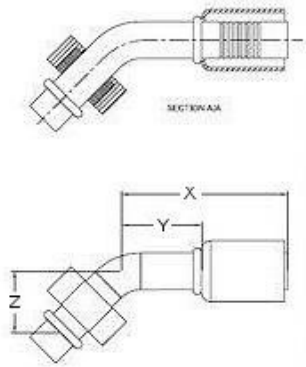

Hose beadlock fitting, 45° female fitting for hose connections. Step Up Step Down.

Type: 45° female O-ring step up - step down

Application: Air conditioning

Material: -

Fitting size: #6

Hose size: 13/32

Thread: 5/8-18 UNF

Type No	Fittings size	Hose size	Thread	X	Y	Z	Weight
525006115	#10	5/8	7/8 - 14 UNF	72	30	0	0
525006114	#8	1/2	3/4 - 16UNF	70	25	0	0
525006113	#6	13/32	5/8-18 UNF	60	25	0	0

This hose specification sheet has been prepared with great care in order to provide you with all the information you need. Written advice must be obtained from Codan Rubber before using any hose with untested media or before using in applications not covered in the product data sheet. Codan Rubber recommends regular maintenance, care and inspection of hoses before use. Hoses should be replaced if any physical damage is seen, especially to the cover of the hose or in the area around the couplings. All products must be stored in accordance with ISO 2230:2002 (Storage of vulcanised Rubber Products).

The individual conditions of an application will affect the life time of each product. Therefore please ensure that resistance to chemicals and cleaning procedures in our written product information is complied with. Codan Rubber's warranty is void in the event of misuse such as excessive bending, crushing, stretching, use with incorrect media or use in environments outside the hose specification.

Please contact Codan Rubber for individual product manufacturing tolerances.

Codan 45° female O-ring

- 45° FEMALE O-RING step up - step down
- 45° FEMALE O-RING
- 45° FEMALE SERVICE O-RING
- 45° MALE O-RING INSERT
- 45° MALE O-RING step up - step down
- 45° MALE O-RING
- 90° FEMALE O-RING step up - step down
- 90° FEMALE O-RING
- 90° FEMALE SERVICE O-RING
- 90° FEMALE SHORT O-RING
- 90° MALE O-RING INSERT
- 90° MALE O-RING step up - step down
- 90° MALE O-RING
- 180° FEMALE O-RING
- REUSEABLE 45° FLANGE FEMALE FITTING
- REUSEABLE 90° FEMALE FITTING
- REUSEABLE 90° FLANGE FEMALE FITTING
- REUSEABLE STRAIGHT FLANGE FEMALE FITTING
- SPLICER STRAIGHT SERVICE O-RING
- STRAIGHT FEMALE O-RING step up - step down
- STRAIGHT FEMALE O-RING
- STRAIGHT MALE O-RING INSERT
- STRAIGHT MALE O-RING step up - step down
- STRAIGHT MALE O-RING
- STRAIGHT SERVICE FEMALE O-RING
- STRAIGHT SERVICE MALE O-RING

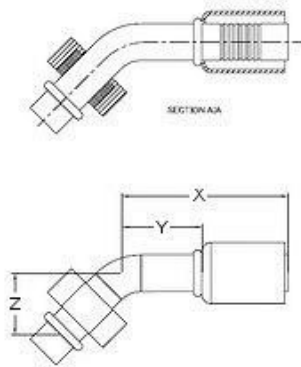

Hose beadlock fitting, 45° female fitting for hose connections

Type: 45° female O-ring
Application: Air conditioning
Material: Steel
Fitting size: #6
Hose size: 5/16
Thread: 5/8-18 UNF

Type No	Fittings size	Hose size	Thread	X	Y	Z	Weight
525006080	#12	5/8	1 1/16 - 14UNF	78	30	32	0
525006078	#8	13/32	3/4 - 16UNF	70	25	21	0
525006077	#6	5/16	5/8-18 UNF	60	25	28	120 g
525006079	#10	1/2	7/8 - 14 UNF	72	30	30	0

This hose specification sheet has been prepared with great care in order to provide you with all the information you need. Written advice must be obtained from Codan Rubber before using any hose with untested media or before using in applications not covered in the product data sheet. Codan Rubber recommends regular maintenance, care and inspection of hoses before use. Hoses should be replaced if any physical damage is seen, especially to the cover of the hose or in the area around the couplings. All products must be stored in accordance with ISO 2230:2002 (Storage of vulcanised Rubber Products).

The individual conditions of an application will affect the life time of each product. Therefore please ensure that resistance to chemicals and cleaning procedures in our written product information is complied with. Codan Rubber's warranty is void in the event of misuse such as excessive bending, crushing, stretching, use with incorrect media or use in environments outside the hose specification.

Please contact Codan Rubber for individual product manufacturing tolerances.

Codan 45° female service O-ring

- 45° FEMALE O-RING step up - step down
- 45° FEMALE O-RING
- 45° FEMALE SERVICE O-RING
- 45° MALE O-RING INSERT
- 45° MALE O-RING step up - step down
- 45° MALE O-RING
- 90° FEMALE O-RING step up - step down
- 90° FEMALE O-RING
- 90° FEMALE SERVICE O-RING
- 90° FEMALE SHORT O-RING
- 90° MALE O-RING INSERT
- 90° MALE O-RING step up - step down
- 90° MALE O-RING
- 180° FEMALE O-RING
- REUSEABLE 45° FLANGE FEMALE FITTING
- REUSEABLE 90° FEMALE FITTING
- REUSEABLE 90° FLANGE FEMALE FITTING
- REUSEABLE STRAIGHT FLANGE FEMALE FITTING
- SPLICER STRAIGHT SERVICE O-RING
- STRAIGHT FEMALE O-RING step up - step down
- STRAIGHT FEMALE O-RING
- STRAIGHT MALE O-RING INSERT
- STRAIGHT MALE O-RING step up - step down
- STRAIGHT MALE O-RING
- STRAIGHT SERVICE FEMALE O-RING
- STRAIGHT SERVICE MALE O-RING

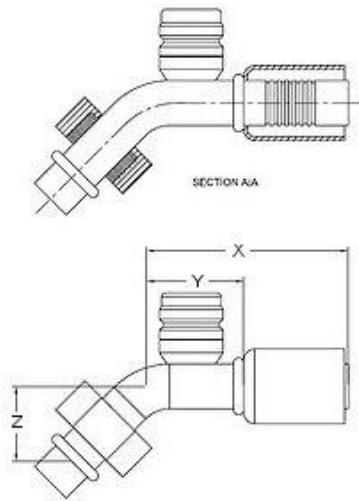

Hose beadlock fitting, 45° female service fitting for hose connections.

Type: 45° female service O-ring
Application: Air conditioning
Material: -
Fitting size: #12
Hose size: 5/8
Thread: 1 1/16 - 14UNF

Type No	Fittings size	Hose size	Thread	X	Y	Z	Weight
525006084	#12	5/8	1 1/16 - 14UNF	78	54	32	0
525006083	#10	1/2	7/8 -14 UNF	72	48	30	0
525006082	#8	13/32	3/4-16 UNF	70	42	21	0
525006081	#6	5/16	5/8 - 18 UNF	60	36	16	0

This hose specification sheet has been prepared with great care in order to provide you with all the information you need. Written advice must be obtained from Codan Rubber before using any hose with untested media or before using in applications not covered in the product data sheet. Codan Rubber recommends regular maintenance, care and inspection of hoses before use. Hoses should be replaced if any physical damage is seen, especially to the cover of the hose or in the area around the couplings. All products must be stored in accordance with ISO 2230:2002 (Storage of vulcanised Rubber Products).

The individual conditions of an application will affect the life time of each product. Therefore please ensure that resistance to chemicals and cleaning procedures in our written product information is complied with. Codan Rubber's warranty is void in the event of misuse such as excessive bending, crushing, stretching, use with incorrect media or use in environments outside the hose specification.

Please contact Codan Rubber for individual product manufacturing tolerances.

Codan 45° male O-ring insert

- 45° FEMALE O-RING step up - step down
- 45° FEMALE O-RING
- 45° FEMALE SERVICE O-RING
- 45° MALE O-RING INSERT
- 45° MALE O-RING step up - step down
- 45° MALE O-RING
- 90° FEMALE O-RING step up - step down
- 90° FEMALE O-RING
- 90° FEMALE SERVICE O-RING
- 90° FEMALE SHORT O-RING
- 90° MALE O-RING INSERT
- 90° MALE O-RING step up - step down
- 90° MALE O-RING
- 180° FEMALE O-RING
- REUSEABLE 45° FLANGE FEMALE FITTING
- REUSEABLE 90° FEMALE FITTING
- REUSEABLE 90° FLANGE FEMALE FITTING
- REUSEABLE STRAIGHT FLANGE FEMALE FITTING
- SPLICER STRAIGHT SERVICE O-RING
- STRAIGHT FEMALE O-RING step up - step down
- STRAIGHT FEMALE O-RING
- STRAIGHT MALE O-RING INSERT
- STRAIGHT MALE O-RING step up - step down
- STRAIGHT MALE O-RING
- STRAIGHT SERVICE FEMALE O-RING
- STRAIGHT SERVICE MALE O-RING

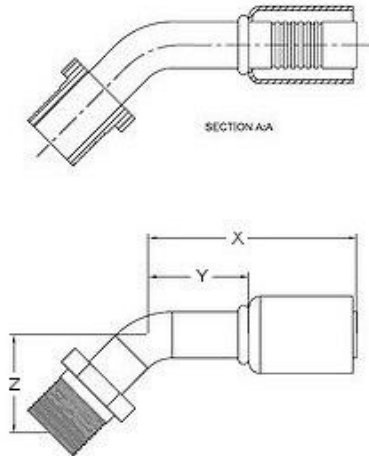

Hose beadlock fitting, 45° female fitting insert for hose connections.

Type: 45° male O-ring insert
Application: Air conditioning
Material: -
Fitting size: #10
Hose size: 1/2
Thread: 7/8 - 14 UNF

Type No	Fittings size	Hose size	Thread	X	Y	Z	Weight
525006141	#10	1/2	7/8 - 14 UNF	0	0	0	0
525006140	#8	13/32	3/4 - 16UNF	0	0	0	0
525006139	#6	5/16	5/8 - 18 UNF	0	0	0	0

Codan 45° male O-ring step up - step down

- 45° FEMALE O-RING step up - step down
- 45° FEMALE O-RING
- 45° FEMALE SERVICE O-RING
- 45° MALE O-RING INSERT
- 45° MALE O-RING step up - step down
- 45° MALE O-RING
- 90° FEMALE O-RING step up - step down
- 90° FEMALE O-RING
- 90° FEMALE SERVICE O-RING
- 90° FEMALE SHORT O-RING
- 90° MALE O-RING INSERT
- 90° MALE O-RING step up - step down
- 90° MALE O-RING
- 180° FEMALE O-RING
- REUSEABLE 45° FLANGE FEMALE FITTING
- REUSEABLE 90° FEMALE FITTING
- REUSEABLE 90° FLANGE FEMALE FITTING
- REUSEABLE STRAIGHT FLANGE FEMALE FITTING
- SPLICER STRAIGHT SERVICE O-RING
- STRAIGHT FEMALE O-RING step up - step down
- STRAIGHT FEMALE O-RING
- STRAIGHT MALE O-RING INSERT
- STRAIGHT MALE O-RING step up - step down
- STRAIGHT MALE O-RING
- STRAIGHT SERVICE FEMALE O-RING
- STRAIGHT SERVICE MALE O-RING

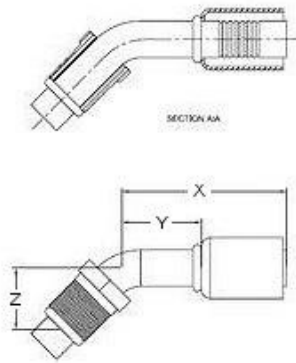

Hose beadlock fitting, 45° male service fitting for hose connections. Step Up Step Down.

Type: 45° male O-ring step up - step down

Application: Air conditioning

Material: -

Fitting size: #6

Hose size: 13/32

Thread: 5/8 UNF

Type No	Fittings size	Hose size	Thread	X	Y	Z	Weight
525006130	#6	13/32	5/8 UNF	64	25	29	0
525006131	#8	5/16	3/4 - 18 UNF	64	30	29	0

This hose specification sheet has been prepared with great care in order to provide you with all the information you need. Written advice must be obtained from Codan Rubber before using any hose with untested media or before using in applications not covered in the product data sheet. Codan Rubber recommends regular maintenance, care and inspection of hoses before use. Hoses should be replaced if any physical damage is seen, especially to the cover of the hose or in the area around the couplings. All products must be stored in accordance with ISO 2230:2002 (Storage of vulcanised Rubber Products).

The individual conditions of an application will affect the life time of each product. Therefore please ensure that resistance to chemicals and cleaning procedures in our written product information is complied with. Codan Rubber's warranty is void in the event of misuse such as excessive bending, crushing, stretching, use with incorrect media or use in environments outside the hose specification.

Please contact Codan Rubber for individual product manufacturing tolerances.

Codan 45° male O-ring

- 45° FEMALE O-RING step up - step down
- 45° FEMALE O-RING
- 45° FEMALE SERVICE O-RING
- 45° MALE O-RING INSERT
- 45° MALE O-RING step up - step down
- 45° MALE O-RING
- 90° FEMALE O-RING step up - step down
- 90° FEMALE O-RING
- 90° FEMALE SERVICE O-RING
- 90° FEMALE SHORT O-RING
- 90° MALE O-RING INSERT
- 90° MALE O-RING step up - step down
- 90° MALE O-RING
- 180° FEMALE O-RING
- REUSEABLE 45° FLANGE FEMALE FITTING
- REUSEABLE 90° FEMALE FITTING
- REUSEABLE 90° FLANGE FEMALE FITTING
- REUSEABLE STRAIGHT FLANGE FEMALE FITTING
- SPLICER STRAIGHT SERVICE O-RING
- STRAIGHT FEMALE O-RING step up - step down
- STRAIGHT FEMALE O-RING
- STRAIGHT MALE O-RING INSERT
- STRAIGHT MALE O-RING step up - step down
- STRAIGHT MALE O-RING
- STRAIGHT SERVICE FEMALE O-RING
- STRAIGHT SERVICE MALE O-RING

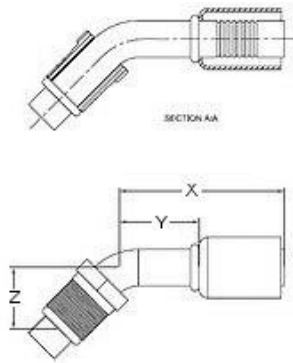

Hose beadlock fitting, 45° male fitting for hose connections

Type: 45° male O-ring
Application: Air conditioning
Material: -
Fitting size: #6
Hose size: 5/16
Thread: 5/8 - 18 UNF

Type No	Fittings size	Hose size	Thread	X	Y	Z	Weight
525006104	#12	5/8	1 1/16 - 16UNF	78	35	0	0
525006103	#10	1/2	7/8-18 UNF	72	30	0	0
525006102	#8	13/32	3/4 - 18 UNF	70	25	0	0
525006101	#6	5/16	5/8 - 18 UNF	60	25	0	0

This hose specification sheet has been prepared with great care in order to provide you with all the information you need. Written advice must be obtained from Codan Rubber before using any hose with untested media or before using in applications not covered in the product data sheet. Codan Rubber recommends regular maintenance, care and inspection of hoses before use. Hoses should be replaced if any physical damage is seen, especially to the cover of the hose or in the area around the couplings. All products must be stored in accordance with ISO 2230:2002 (Storage of vulcanised Rubber Products).

The individual conditions of an application will affect the life time of each product. Therefore please ensure that resistance to chemicals and cleaning procedures in our written product information is complied with. Codan Rubber's warranty is void in the event of misuse such as excessive bending, crushing, stretching, use with incorrect media or use in environments outside the hose specification.

Please contact Codan Rubber for individual product manufacturing tolerances.

Codan 90° female O-ring step up - step down

- 45° FEMALE O-RING step up - step down
- 45° FEMALE O-RING
- 45° FEMALE SERVICE O-RING
- 45° MALE O-RING INSERT
- 45° MALE O-RING step up - step down
- 45° MALE O-RING
- 90° FEMALE O-RING step up - step down
- 90° FEMALE O-RING
- 90° FEMALE SERVICE O-RING
- 90° FEMALE SHORT O-RING
- 90° MALE O-RING INSERT
- 90° MALE O-RING step up - step down
- 90° MALE O-RING
- 180° FEMALE O-RING
- REUSEABLE 45° FLANGE FEMALE FITTING
- REUSEABLE 90° FEMALE FITTING
- REUSEABLE 90° FLANGE FEMALE FITTING
- REUSEABLE STRAIGHT FLANGE FEMALE FITTING
- SPLICER STRAIGHT SERVICE O-RING
- STRAIGHT FEMALE O-RING step up - step down
- STRAIGHT FEMALE O-RING
- STRAIGHT MALE O-RING INSERT
- STRAIGHT MALE O-RING step up - step down
- STRAIGHT MALE O-RING
- STRAIGHT SERVICE FEMALE O-RING
- STRAIGHT SERVICE MALE O-RING

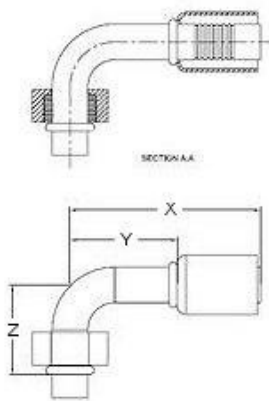

Hose beadlock fitting, 90° female service fitting for hose connections.

Type: 90° female O-ring step up - step down
Application: Air conditioning
Material: -
Fitting size: #6
Hose size: 5/16
Thread: 3/4 - 16 UNF

Type No	Fittings size	Hose size	Thread	X	Y	Z	Weight
25006117	#10	1/2	3/4 - 16 UNF	84	46	50	0
525006116	#8	13/32	5/8 - 18 UNF	74	36	40	0
525006118	#10	1/2	1 1/16 - 14 UNF	80	45	50	0
525006119	#12	5/8	7/8 - 14 UNF	84	30	65	0
525006120	#6	5/16	3/4 - 16 UNF	74	36	28	0

This hose specification sheet has been prepared with great care in order to provide you with all the information you need. Written advice must be obtained from Codan Rubber before using any hose with untested media or before using in applications not covered in the product data sheet. Codan Rubber recommends regular maintenance, care and inspection of hoses before use. Hoses should be replaced if any physical damage is seen, especially to the cover of the hose or in the area around the couplings. All products must be stored in accordance with ISO 2230:2002 (Storage of vulcanised Rubber Products).

The individual conditions of an application will affect the life time of each product. Therefore please ensure that resistance to chemicals and cleaning procedures in our written product information is complied with. Codan Rubber's warranty is void in the event of misuse such as excessive bending, crushing, stretching, use with incorrect media or use in environments outside the hose specification.

Please contact Codan Rubber for individual product manufacturing tolerances.

Codan 90° female O-ring

- 45° FEMALE O-RING step up - step down
- 45° FEMALE O-RING
- 45° FEMALE SERVICE O-RING
- 45° MALE O-RING INSERT
- 45° MALE O-RING step up - step down
- 45° MALE O-RING
- 90° FEMALE O-RING step up - step down
- 90° FEMALE O-RING
- 90° FEMALE SERVICE O-RING
- 90° FEMALE SHORT O-RING
- 90° MALE O-RING INSERT
- 90° MALE O-RING step up - step down
- 90° MALE O-RING
- 180° FEMALE O-RING
- REUSEABLE 45° FLANGE FEMALE FITTING
- REUSEABLE 90° FEMALE FITTING
- REUSEABLE 90° FLANGE FEMALE FITTING
- REUSEABLE STRAIGHT FLANGE FEMALE FITTING
- SPLICER STRAIGHT SERVICE O-RING
- STRAIGHT FEMALE O-RING step up - step down
- STRAIGHT FEMALE O-RING
- STRAIGHT MALE O-RING INSERT
- STRAIGHT MALE O-RING step up - step down
- STRAIGHT MALE O-RING
- STRAIGHT SERVICE FEMALE O-RING
- STRAIGHT SERVICE MALE O-RING

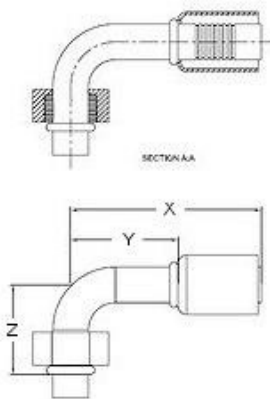

Hose beadlock fitting, 90° female fitting for hose connections.

Type: 90° female O-ring
Application: Air conditioning
Material: -
Fitting size: #6
Hose size: 5/16
Thread: 5/8- 18 UNF

Type No	Fittings size	Hose size	Thread	X	Y	Z	Weight
525006085	#6	5/16	5/8- 18 UNF	74	30	28	0
525006086	#8	13/32	7/8- 16 UNF	80	36	40	0
525006087	#10	1/2	7/8-14 UNF	84	40	50	0
525006088	#12	5/8	1 1/16 - 14 UNF	89	44	65	0

This hose specification sheet has been prepared with great care in order to provide you with all the information you need. Written advice must be obtained from Codan Rubber before using any hose with untested media or before using in applications not covered in the product data sheet. Codan Rubber recommends regular maintenance, care and inspection of hoses before use. Hoses should be replaced if any physical damage is seen, especially to the cover of the hose or in the area around the couplings. All products must be stored in accordance with ISO 2230:2002 (Storage of vulcanised Rubber Products).

The individual conditions of an application will affect the life time of each product. Therefore please ensure that resistance to chemicals and cleaning procedures in our written product information is complied with. Codan Rubber's warranty is void in the event of misuse such as excessive bending, crushing, stretching, use with incorrect media or use in environments outside the hose specification.

Please contact Codan Rubber for individual product manufacturing tolerances.

Codan 90° female service O-ring

- 45° FEMALE O-RING step up - step down
- 45° FEMALE O-RING
- 45° FEMALE SERVICE O-RING
- 45° MALE O-RING INSERT
- 45° MALE O-RING step up - step down
- 45° MALE O-RING
- 90° FEMALE O-RING step up - step down
- 90° FEMALE O-RING
- 90° FEMALE SERVICE O-RING
- 90° FEMALE SHORT O-RING
- 90° MALE O-RING INSERT
- 90° MALE O-RING step up - step down
- 90° MALE O-RING
- 180° FEMALE O-RING
- REUSEABLE 45° FLANGE FEMALE FITTING
- REUSEABLE 90° FEMALE FITTING
- REUSEABLE 90° FLANGE FEMALE FITTING
- REUSEABLE STRAIGHT FLANGE FEMALE FITTING
- SPLICER STRAIGHT SERVICE O-RING
- STRAIGHT FEMALE O-RING step up - step down
- STRAIGHT FEMALE O-RING
- STRAIGHT MALE O-RING INSERT
- STRAIGHT MALE O-RING step up - step down
- STRAIGHT MALE O-RING
- STRAIGHT SERVICE FEMALE O-RING
- STRAIGHT SERVICE MALE O-RING



Hose beadlock fitting, 90° female service fitting for hose connections.

Type: 90° female service O-ring
Application: Air conditioning
Material: -
Fitting size: #12
Hose size: 5/8
Thread: 1 1/16 - 14 UNF

Type No	Fittings size	Hose size	Thread	X	Y	Z	Weight
525006089	#6	5/16	5/8 - 18 UNF	74	36	28	0
525006090	#8	13/32	3/4 - 16UNF	80	42	40	0
525006091	#10	1/2	7/8 - 14 UNF	84	48	55	0
525006092	#12	5/8	1 1/16 - 14 UNF	89	54	65	0

This hose specification sheet has been prepared with great care in order to provide you with all the information you need. Written advice must be obtained from Codan Rubber before using any hose with untested media or before using in applications not covered in the product data sheet. Codan Rubber recommends regular maintenance, care and inspection of hoses before use. Hoses should be replaced if any physical damage is seen, especially to the cover of the hose or in the area around the couplings. All products must be stored in accordance with ISO 2230:2002 (Storage of vulcanised Rubber Products).

The individual conditions of an application will affect the life time of each product. Therefore please ensure that resistance to chemicals and cleaning procedures in our written product information is complied with. Codan Rubber's warranty is void in the event of misuse such as excessive bending, crushing, stretching, use with incorrect media or use in environments outside the hose specification.

Please contact Codan Rubber for individual product manufacturing tolerances.

Codan 90° female short O-ring

- 45° FEMALE O-RING step up - step down
- 45° FEMALE O-RING
- 45° FEMALE SERVICE O-RING
- 45° MALE O-RING INSERT
- 45° MALE O-RING step up - step down
- 45° MALE O-RING
- 90° FEMALE O-RING step up - step down
- 90° FEMALE O-RING
- 90° FEMALE SERVICE O-RING
- 90° FEMALE SHORT O-RING
- 90° MALE O-RING INSERT
- 90° MALE O-RING step up - step down
- 90° MALE O-RING
- 180° FEMALE O-RING
- REUSEABLE 45° FLANGE FEMALE FITTING
- REUSEABLE 90° FEMALE FITTING
- REUSEABLE 90° FLANGE FEMALE FITTING
- REUSEABLE STRAIGHT FLANGE FEMALE FITTING
- SPLICER STRAIGHT SERVICE O-RING
- STRAIGHT FEMALE O-RING step up - step down
- STRAIGHT FEMALE O-RING
- STRAIGHT MALE O-RING INSERT
- STRAIGHT MALE O-RING step up - step down
- STRAIGHT MALE O-RING
- STRAIGHT SERVICE FEMALE O-RING
- STRAIGHT SERVICE MALE O-RING

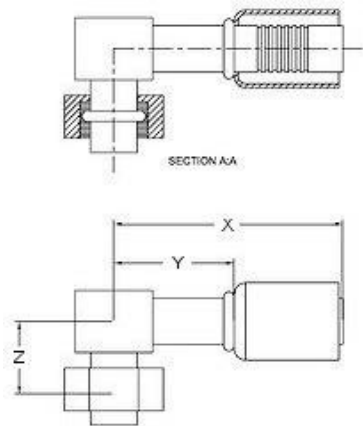

Hose beadlock fitting, 90° female short fitting for hose connections.

Type: 90° female short O-ring
Application: Air conditioning
Material: -
Fitting size: #8
Hose size: 13/32
Thread: 3/4 - 16 UNF

Type No	Fittings size	Hose size	Thread	X	Y	Z	Weight
525006121	#8	13/32	3/4 - 16 UNF	0	0	0	0
525006122	#10	1/2	7/8 14 UNF	0	0	0	0

This hose specification sheet has been prepared with great care in order to provide you with all the information you need. Written advice must be obtained from Codan Rubber before using any hose with untested media or before using in applications not covered in the product data sheet. Codan Rubber recommends regular maintenance, care and inspection of hoses before use. Hoses should be replaced if any physical damage is seen, especially to the cover of the hose or in the area around the couplings. All products must be stored in accordance with ISO 2230:2002 (Storage of vulcanised Rubber Products).

The individual conditions of an application will affect the life time of each product. Therefore please ensure that resistance to chemicals and cleaning procedures in our written product information is complied with. Codan Rubber's warranty is void in the event of misuse such as excessive bending, crushing, stretching, use with incorrect media or use in environments outside the hose specification.

Please contact Codan Rubber for individual product manufacturing tolerances.

Codan 90° male O-ring insert

- 45° FEMALE O-RING step up - step down
- 45° FEMALE O-RING
- 45° FEMALE SERVICE O-RING
- 45° MALE O-RING INSERT
- 45° MALE O-RING step up - step down
- 45° MALE O-RING
- 90° FEMALE O-RING step up - step down
- 90° FEMALE O-RING
- 90° FEMALE SERVICE O-RING
- 90° FEMALE SHORT O-RING
- 90° MALE O-RING INSERT
- 90° MALE O-RING step up - step down
- 90° MALE O-RING
- 180° FEMALE O-RING
- REUSEABLE 45° FLANGE FEMALE FITTING
- REUSEABLE 90° FEMALE FITTING
- REUSEABLE 90° FLANGE FEMALE FITTING
- REUSEABLE STRAIGHT FLANGE FEMALE FITTING
- SPLICER STRAIGHT SERVICE O-RING
- STRAIGHT FEMALE O-RING step up - step down
- STRAIGHT FEMALE O-RING
- STRAIGHT MALE O-RING INSERT
- STRAIGHT MALE O-RING step up - step down
- STRAIGHT MALE O-RING
- STRAIGHT SERVICE FEMALE O-RING
- STRAIGHT SERVICE MALE O-RING



Hose beadlock fitting, 90° female insert fitting for hose connections.

Type: 90° male O-ring insert
Application: Air conditioning
Material: -
Fitting size: #10
Hose size: 1/2
Thread: 7/8 - 14 UNF

Type No	Fittings size	Hose size	Thread	X	Y	Z	Weight
525006144	#10	1/2	7/8 - 14 UNF	0	0	0	0
525006143	#8	13/32	7/8 - 14 UNF	0	0	0	0
525006142	#6	5/16	5/8 - 18 UNF	0	0	0	0

This hose specification sheet has been prepared with great care in order to provide you with all the information you need. Written advice must be obtained from Codan Rubber before using any hose with untested media or before using in applications not covered in the product data sheet. Codan Rubber recommends regular maintenance, care and inspection of hoses before use. Hoses should be replaced if any physical damage is seen, especially to the cover of the hose or in the area around the couplings. All products must be stored in accordance with ISO 2230:2002 (Storage of vulcanised Rubber Products).

The individual conditions of an application will affect the life time of each product. Therefore please ensure that resistance to chemicals and cleaning procedures in our written product information is complied with. Codan Rubber's warranty is void in the event of misuse such as excessive bending, crushing, stretching, use with incorrect media or use in environments outside the hose specification.

Please contact Codan Rubber for individual product manufacturing tolerances.

Codan 90° male O-ring step up - step down

- 45° FEMALE O-RING step up - step down
- 45° FEMALE O-RING
- 45° FEMALE SERVICE O-RING
- 45° MALE O-RING INSERT
- 45° MALE O-RING step up - step down
- 45° MALE O-RING
- 90° FEMALE O-RING step up - step down
- 90° FEMALE O-RING
- 90° FEMALE SERVICE O-RING
- 90° FEMALE SHORT O-RING
- 90° MALE O-RING INSERT
- 90° MALE O-RING step up - step down
- 90° MALE O-RING
- 180° FEMALE O-RING
- REUSEABLE 45° FLANGE FEMALE FITTING
- REUSEABLE 90° FEMALE FITTING
- REUSEABLE 90° FLANGE FEMALE FITTING
- REUSEABLE STRAIGHT FLANGE FEMALE FITTING
- SPLICER STRAIGHT SERVICE O-RING
- STRAIGHT FEMALE O-RING step up - step down
- STRAIGHT FEMALE O-RING
- STRAIGHT MALE O-RING INSERT
- STRAIGHT MALE O-RING step up - step down
- STRAIGHT MALE O-RING
- STRAIGHT SERVICE FEMALE O-RING
- STRAIGHT SERVICE MALE O-RING

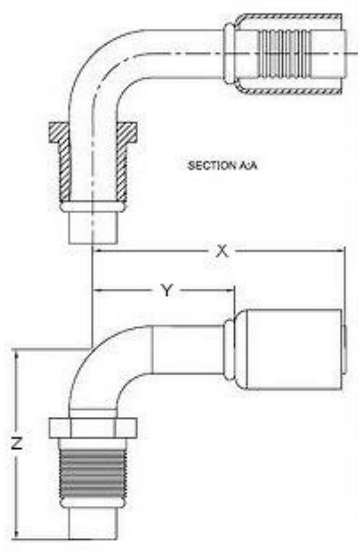

Hose beadlock fitting, 90° male fitting for hose connections Step Up Step Down.

Type: 90° male O-ring step up - step down
Application: Air conditioning
Material: -
Fitting size: #10
Hose size: 5/8
Thread: 7/8-18 UNF

Type No	Fittings size	Hose size	Thread	X	Y	Z	Weight
525006132	#6	13/32	5/8 - 18 UNF	74	30	44	0
525006133	#10	5/8	7/8-18 UNF	84	36	44	0
525006134	#8	5/16	3/4-18 UNF	74	36	44	0

This hose specification sheet has been prepared with great care in order to provide you with all the information you need. Written advice must be obtained from Codan Rubber before using any hose with untested media or before using in applications not covered in the product data sheet. Codan Rubber recommends regular maintenance, care and inspection of hoses before use. Hoses should be replaced if any physical damage is seen, especially to the cover of the hose or in the area around the couplings. All products must be stored in accordance with ISO 2230:2002 (Storage of vulcanised Rubber Products).

The individual conditions of an application will affect the life time of each product. Therefore please ensure that resistance to chemicals and cleaning procedures in our written product information is complied with. Codan Rubber's warranty is void in the event of misuse such as excessive bending, crushing, stretching, use with incorrect media or use in environments outside the hose specification.

Please contact Codan Rubber for individual product manufacturing tolerances.

Codan 90° male O-ring

- 45° FEMALE O-RING step up - step down
- 45° FEMALE O-RING
- 45° FEMALE SERVICE O-RING
- 45° MALE O-RING INSERT
- 45° MALE O-RING step up - step down
- 45° MALE O-RING
- 90° FEMALE O-RING step up - step down
- 90° FEMALE O-RING
- 90° FEMALE SERVICE O-RING
- 90° FEMALE SHORT O-RING
- 90° MALE O-RING INSERT
- 90° MALE O-RING step up - step down
- 90° MALE O-RING
- 180° FEMALE O-RING
- REUSEABLE 45° FLANGE FEMALE FITTING
- REUSEABLE 90° FEMALE FITTING
- REUSEABLE 90° FLANGE FEMALE FITTING
- REUSEABLE STRAIGHT FLANGE FEMALE FITTING
- SPLICER STRAIGHT SERVICE O-RING
- STRAIGHT FEMALE O-RING step up - step down
- STRAIGHT FEMALE O-RING
- STRAIGHT MALE O-RING INSERT
- STRAIGHT MALE O-RING step up - step down
- STRAIGHT MALE O-RING
- STRAIGHT SERVICE FEMALE O-RING
- STRAIGHT SERVICE MALE O-RING

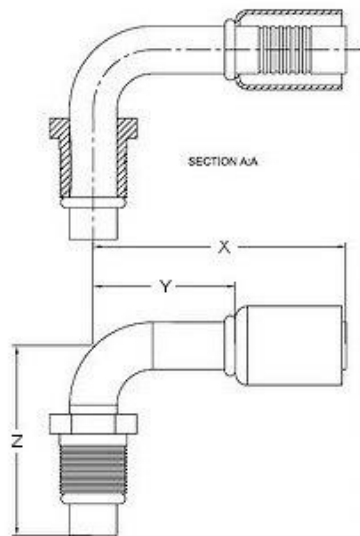

Hose beadlock fitting, 90° male fitting for hose connections.

Type: 90° male O-ring
Application: Air conditioning
Material: -
Fitting size: #12
Hose size: 5/8
Thread: 1 1/16 - 16 UNF

Type No	Fittings size	Hose size	Thread	X	Y	Z	Weight
525006105	#6	5/16	5/8 - 18 UNF	74	30	0	0
525006106	#8	13/32	7/8-18 UNF	80	36	0	0
525006107	#10	1/2	7/8-18 UNF	84	48	0	0
525006108	#12	5/8	1 1/16 - 16 UNF	89	51	0	0

Codan 180° female O-ring

- 45° FEMALE O-RING step up - step down
- 45° FEMALE O-RING
- 45° FEMALE SERVICE O-RING
- 45° MALE O-RING INSERT
- 45° MALE O-RING step up - step down
- 45° MALE O-RING
- 90° FEMALE O-RING step up - step down
- 90° FEMALE O-RING
- 90° FEMALE SERVICE O-RING
- 90° FEMALE SHORT O-RING
- 90° MALE O-RING INSERT
- 90° MALE O-RING step up - step down
- 90° MALE O-RING
- 180° FEMALE O-RING
- REUSEABLE 45° FLANGE FEMALE FITTING
- REUSEABLE 90° FEMALE FITTING
- REUSEABLE 90° FLANGE FEMALE FITTING
- REUSEABLE STRAIGHT FLANGE FEMALE FITTING
- SPLICER STRAIGHT SERVICE O-RING
- STRAIGHT FEMALE O-RING step up - step down
- STRAIGHT FEMALE O-RING
- STRAIGHT MALE O-RING INSERT
- STRAIGHT MALE O-RING step up - step down
- STRAIGHT MALE O-RING
- STRAIGHT SERVICE FEMALE O-RING
- STRAIGHT SERVICE MALE O-RING

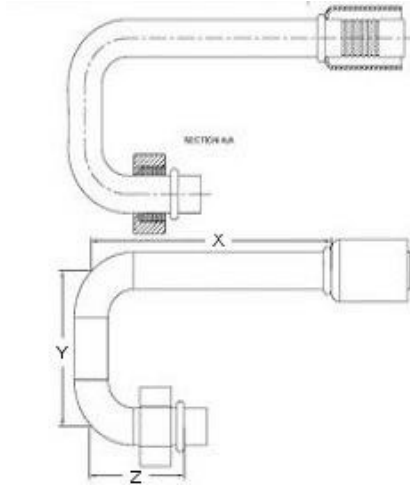

Hose beadlock fitting, 180° female fitting for hose connections.

Type: 180° female O-ring
Application: Air conditioning
Material: -
Fitting size: #12
Hose size: 5/8
Thread: -

Type No	Fittings size	Hose size	Thread	X	Y	Z	Weight
525006126	#12	5/8	-	0	0	0	0
525006125	#10	1/2	-	0	0	0	0
525006124	#8	13/32	-	0	0	0	0
525006123	#6	5/16	-	0	0	0	0

Codan Reuseable 45° flange female fitting

- 45° FEMALE O-RING step up - step down
- 45° FEMALE O-RING
- 45° FEMALE SERVICE O-RING
- 45° MALE O-RING INSERT
- 45° MALE O-RING step up - step down
- 45° MALE O-RING
- 90° FEMALE O-RING step up - step down
- 90° FEMALE O-RING
- 90° FEMALE SERVICE O-RING
- 90° FEMALE SHORT O-RING
- 90° MALE O-RING INSERT
- 90° MALE O-RING step up - step down
- 90° MALE O-RING
- 180° FEMALE O-RING
- REUSEABLE 45° FLANGE FEMALE FITTING
- REUSEABLE 90° FEMALE FITTING
- REUSEABLE 90° FLANGE FEMALE FITTING
- REUSEABLE STRAIGHT FLANGE FEMALE FITTING
- SPLICER STRAIGHT SERVICE O-RING
- STRAIGHT FEMALE O-RING step up - step down
- STRAIGHT FEMALE O-RING
- STRAIGHT MALE O-RING INSERT
- STRAIGHT MALE O-RING step up - step down
- STRAIGHT MALE O-RING
- STRAIGHT SERVICE FEMALE O-RING
- STRAIGHT SERVICE MALE O-RING

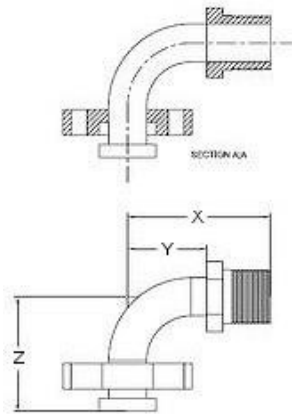

Hose fitting, 45° reuseable flange female fitting for hose connections. Packed with reuseable ferrule.

Type: Reuseable 45° flange female fitting

Application: Air conditioning

Material: -

Fitting size: #20

Hose size: 1 1/8

Thread: -

Type No	Fittings size	Hose size	Thread	X	Y	Z	Weight
519313199	#16	7/8	-	0	0	0	0
519313999	#20	1 1/8	-	0	0	0	0

Codan Reuseable 90° female fitting

- 45° FEMALE O-RING step up - step down
- 45° FEMALE O-RING
- 45° FEMALE SERVICE O-RING
- 45° MALE O-RING INSERT
- 45° MALE O-RING step up - step down
- 45° MALE O-RING
- 90° FEMALE O-RING step up - step down
- 90° FEMALE O-RING
- 90° FEMALE SERVICE O-RING
- 90° FEMALE SHORT O-RING
- 90° MALE O-RING INSERT
- 90° MALE O-RING step up - step down
- 90° MALE O-RING
- 180° FEMALE O-RING
- REUSEABLE 45° FLANGE FEMALE FITTING
- REUSEABLE 90° FEMALE FITTING
- REUSEABLE 90° FLANGE FEMALE FITTING
- REUSEABLE STRAIGHT FLANGE FEMALE FITTING
- SPLICER STRAIGHT SERVICE O-RING
- STRAIGHT FEMALE O-RING step up - step down
- STRAIGHT FEMALE O-RING
- STRAIGHT MALE O-RING INSERT
- STRAIGHT MALE O-RING step up - step down
- STRAIGHT MALE O-RING
- STRAIGHT SERVICE FEMALE O-RING
- STRAIGHT SERVICE MALE O-RING

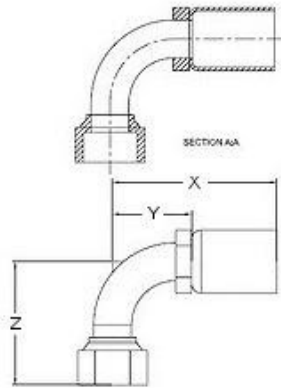

Hose fitting, 90° reusable female fitting for hose connections. Packed with reusable ferrule.

Type: Reusable 90° female fitting

Application: Air conditioning

Material: -

Fitting size: #16

Hose size: 7/8

Thread: -

Type No	Fittings size	Hose size	Thread	X	Y	Z	Weight
519312100	#16	7/8	-	0	0	0	0
519312100	#16	7/8	-	0	0	0	0
519312101	#20	1 1/8	-	0	0	0	0
519312101	#20	1 1/8	-	0	0	0	0

Codan Reuseable 90° flange female fitting

- 45° FEMALE O-RING step up - step down
- 45° FEMALE O-RING
- 45° FEMALE SERVICE O-RING
- 45° MALE O-RING INSERT
- 45° MALE O-RING step up - step down
- 45° MALE O-RING
- 90° FEMALE O-RING step up - step down
- 90° FEMALE O-RING
- 90° FEMALE SERVICE O-RING
- 90° FEMALE SHORT O-RING
- 90° MALE O-RING INSERT
- 90° MALE O-RING step up - step down
- 90° MALE O-RING
- 180° FEMALE O-RING
- REUSEABLE 45° FLANGE FEMALE FITTING
- REUSEABLE 90° FEMALE FITTING
- REUSEABLE 90° FLANGE FEMALE FITTING
- REUSEABLE STRAIGHT FLANGE FEMALE FITTING
- SPLICER STRAIGHT SERVICE O-RING
- STRAIGHT FEMALE O-RING step up - step down
- STRAIGHT FEMALE O-RING
- STRAIGHT MALE O-RING INSERT
- STRAIGHT MALE O-RING step up - step down
- STRAIGHT MALE O-RING
- STRAIGHT SERVICE FEMALE O-RING
- STRAIGHT SERVICE MALE O-RING

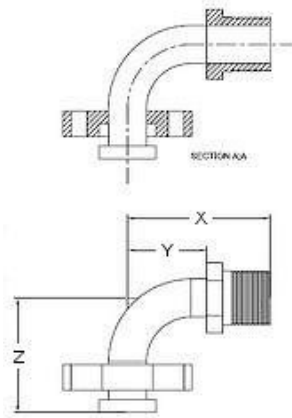

Hose fitting, 90° flange reuseable female fitting for hose connections. Packed with reuseable ferrule.

Type: Reuseable 90° flange female fitting
Application: Air conditioning
Material: -
Fitting size: #16
Hose size: 7/8
Thread: -

Type No	Fittings size	Hose size	Thread	X	Y	Z	Weight
519312199	#16	7/8	-	0	0	0	0
519312999	#20	1 1/8	-	0	0	0	0

This hose specification sheet has been prepared with great care in order to provide you with all the information you need. Written advice must be obtained from Codan Rubber before using any hose with untested media or before using in applications not covered in the product data sheet. Codan Rubber recommends regular maintenance, care and inspection of hoses before use. Hoses should be replaced if any physical damage is seen, especially to the cover of the hose or in the area around the couplings. All products must be stored in accordance with ISO 2230:2002 (Storage of vulcanised Rubber Products).

The individual conditions of an application will affect the life time of each product. Therefore please ensure that resistance to chemicals and cleaning procedures in our written product information is complied with. Codan Rubber's warranty is void in the event of misuse such as excessive bending, crushing, stretching, use with incorrect media or use in environments outside the hose specification.

Please contact Codan Rubber for individual product manufacturing tolerances.

Codan Reuseable straight flange female fitting

- 45° FEMALE O-RING step up - step down
- 45° FEMALE O-RING
- 45° FEMALE SERVICE O-RING
- 45° MALE O-RING INSERT
- 45° MALE O-RING step up - step down
- 45° MALE O-RING
- 90° FEMALE O-RING step up - step down
- 90° FEMALE O-RING
- 90° FEMALE SERVICE O-RING
- 90° FEMALE SHORT O-RING
- 90° MALE O-RING INSERT
- 90° MALE O-RING step up - step down
- 90° MALE O-RING
- 180° FEMALE O-RING
- REUSEABLE 45° FLANGE FEMALE FITTING
- REUSEABLE 90° FEMALE FITTING
- REUSEABLE 90° FLANGE FEMALE FITTING
- REUSEABLE STRAIGHT FLANGE FEMALE FITTING
- SPLICER STRAIGHT SERVICE O-RING
- STRAIGHT FEMALE O-RING step up - step down
- STRAIGHT FEMALE O-RING
- STRAIGHT MALE O-RING INSERT
- STRAIGHT MALE O-RING step up - step down
- STRAIGHT MALE O-RING
- STRAIGHT SERVICE FEMALE O-RING
- STRAIGHT SERVICE MALE O-RING

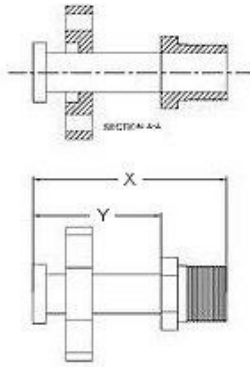

Hose fitting, straight flange reusable female fitting for hose connections. Packed with reusable ferrule.

Type: Reuseable straight flange female fitting

Application: Air conditioning

Material: -

Fitting size: #16

Hose size: 7/8

Thread: -

Type No	Fittings size	Hose size	Thread	X	Y	Z	Weight
519311199	#16	7/8	-	0	0	0	0
519311999	#20	1 1/8	-	0	0	0	0

Codan Splicer straight service O-ring

- 45° FEMALE O-RING step up - step down
- 45° FEMALE O-RING
- 45° FEMALE SERVICE O-RING
- 45° MALE O-RING INSERT
- 45° MALE O-RING step up - step down
- 45° MALE O-RING
- 90° FEMALE O-RING step up - step down
- 90° FEMALE O-RING
- 90° FEMALE SERVICE O-RING
- 90° FEMALE SHORT O-RING
- 90° MALE O-RING INSERT
- 90° MALE O-RING step up - step down
- 90° MALE O-RING
- 180° FEMALE O-RING
- REUSEABLE 45° FLANGE FEMALE FITTING
- REUSEABLE 90° FEMALE FITTING
- REUSEABLE 90° FLANGE FEMALE FITTING
- REUSEABLE STRAIGHT FLANGE FEMALE FITTING
- SPLICER STRAIGHT SERVICE O-RING
- STRAIGHT FEMALE O-RING step up - step down
- STRAIGHT FEMALE O-RING
- STRAIGHT MALE O-RING INSERT
- STRAIGHT MALE O-RING step up - step down
- STRAIGHT MALE O-RING
- STRAIGHT SERVICE FEMALE O-RING
- STRAIGHT SERVICE MALE O-RING

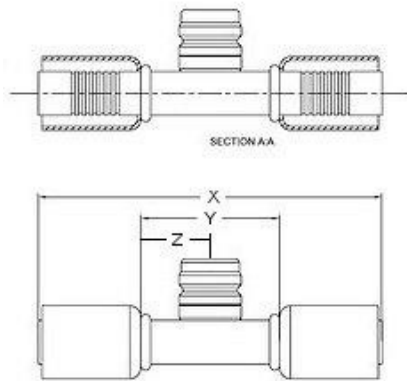

Hose fitting, splicer straight service female fitting for hose connections.

Type: Splicer straight service O-ring
Application: Air conditioning
Material: -
Fitting size: #6
Hose size: 5/16
Thread: -

Type No	Fittings size	Hose size	Thread	X	Y	Z	Weight
525006145	#6	5/16	-	119	36	0	0
525006146	#8	13/32	-	123	36	0	0
525006147	#10	1/2	-	131	42	0	0
525006148	#12	5/8	-	138	42	0	0

This hose specification sheet has been prepared with great care in order to provide you with all the information you need. Written advice must be obtained from Codan Rubber before using any hose with untested media or before using in applications not covered in the product data sheet. Codan Rubber recommends regular maintenance, care and inspection of hoses before use. Hoses should be replaced if any physical damage is seen, especially to the cover of the hose or in the area around the couplings. All products must be stored in accordance with ISO 2230:2002 (Storage of vulcanised Rubber Products).

The individual conditions of an application will affect the life time of each product. Therefore please ensure that resistance to chemicals and cleaning procedures in our written product information is complied with. Codan Rubber's warranty is void in the event of misuse such as excessive bending, crushing, stretching, use with incorrect media or use in environments outside the hose specification.

Please contact Codan Rubber for individual product manufacturing tolerances.

Codan Straight female O-ring step up - step down

- 45° FEMALE O-RING step up - step down
- 45° FEMALE O-RING
- 45° FEMALE SERVICE O-RING
- 45° MALE O-RING INSERT
- 45° MALE O-RING step up - step down
- 45° MALE O-RING
- 90° FEMALE O-RING step up - step down
- 90° FEMALE O-RING
- 90° FEMALE SERVICE O-RING
- 90° FEMALE SHORT O-RING
- 90° MALE O-RING INSERT
- 90° MALE O-RING step up - step down
- 90° MALE O-RING
- 180° FEMALE O-RING
- REUSEABLE 45° FLANGE FEMALE FITTING
- REUSEABLE 90° FEMALE FITTING
- REUSEABLE 90° FLANGE FEMALE FITTING
- REUSEABLE STRAIGHT FLANGE FEMALE FITTING
- SPLICER STRAIGHT SERVICE O-RING
- STRAIGHT FEMALE O-RING step up - step down
- STRAIGHT FEMALE O-RING
- STRAIGHT MALE O-RING INSERT
- STRAIGHT MALE O-RING step up - step down
- STRAIGHT MALE O-RING
- STRAIGHT SERVICE FEMALE O-RING
- STRAIGHT SERVICE MALE O-RING

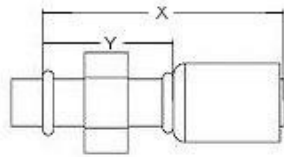
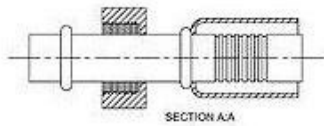

Hose beadlock fitting, straight female fitting for hose connections. Step Up Step Down.

Type: Straight female O-ring step up - step down
Application: Air conditioning
Material: -
Fitting size: #8
Hose size: 13/32
Thread: 5/8 - 18 UNF

Type No	Fittings size	Hose size	Thread	X	Y	Z	Weight
525006109	#8	13/32	5/8 - 18 UNF	74	35	0	0
525006110	#10	1/2	3/4 - 16 UNF	91	40	0	0
525006111	#12	5/8	7/8 - 14 UNF	98	46	0	0
525006112	#6	5/16	3/4 16UNF	81	35	0	0

Codan Straight female O-ring

- 45° FEMALE O-RING step up - step down
- 45° FEMALE O-RING
- 45° FEMALE SERVICE O-RING
- 45° MALE O-RING INSERT
- 45° MALE O-RING step up - step down
- 45° MALE O-RING
- 90° FEMALE O-RING step up - step down
- 90° FEMALE O-RING
- 90° FEMALE SERVICE O-RING
- 90° FEMALE SHORT O-RING
- 90° MALE O-RING INSERT
- 90° MALE O-RING step up - step down
- 90° MALE O-RING
- 180° FEMALE O-RING
- REUSEABLE 45° FLANGE FEMALE FITTING
- REUSEABLE 90° FEMALE FITTING
- REUSEABLE 90° FLANGE FEMALE FITTING
- REUSEABLE STRAIGHT FLANGE FEMALE FITTING
- SPLICER STRAIGHT SERVICE O-RING
- STRAIGHT FEMALE O-RING step up - step down
- STRAIGHT FEMALE O-RING
- STRAIGHT MALE O-RING INSERT
- STRAIGHT MALE O-RING step up - step down
- STRAIGHT MALE O-RING
- STRAIGHT SERVICE FEMALE O-RING
- STRAIGHT SERVICE MALE O-RING

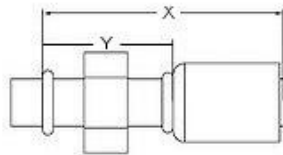
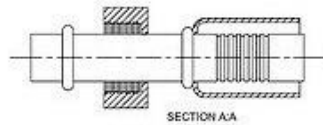

Hose beadlock fitting, straight female fitting for hose connections.

Type: Straight female O-ring
Application: Air conditioning
Material: -
Fitting size: #10
Hose size: 1/2
Thread: 7/8 - 14 UNF

Type No	Fittings size	Hose size	Thread	X	Y	Z	Weight
525006069	#6	5/16	5/8-18 UNF	45	20	50	128
525006070	#8	13/32	3/4 - 16 UNF	74	35	0	130
525006071	#10	1/2	7/8 - 14 UNF	76	40	0	0
525006072	#12	5/8	1 1/16 - 14UNF	98	40	0	0

This hose specification sheet has been prepared with great care in order to provide you with all the information you need. Written advice must be obtained from Codan Rubber before using any hose with untested media or before using in applications not covered in the product data sheet. Codan Rubber recommends regular maintenance, care and inspection of hoses before use. Hoses should be replaced if any physical damage is seen, especially to the cover of the hose or in the area around the couplings. All products must be stored in accordance with ISO 2230:2002 (Storage of vulcanised Rubber Products).

The individual conditions of an application will affect the life time of each product. Therefore please ensure that resistance to chemicals and cleaning procedures in our written product information is complied with. Codan Rubber's warranty is void in the event of misuse such as excessive bending, crushing, stretching, use with incorrect media or use in environments outside the hose specification.

Please contact Codan Rubber for individual product manufacturing tolerances.

Codan Straight male O-ring insert

- 45° FEMALE O-RING step up - step down
- 45° FEMALE O-RING
- 45° FEMALE SERVICE O-RING
- 45° MALE O-RING INSERT
- 45° MALE O-RING step up - step down
- 45° MALE O-RING
- 90° FEMALE O-RING step up - step down
- 90° FEMALE O-RING
- 90° FEMALE SERVICE O-RING
- 90° FEMALE SHORT O-RING
- 90° MALE O-RING INSERT
- 90° MALE O-RING step up - step down
- 90° MALE O-RING
- 180° FEMALE O-RING
- REUSEABLE 45° FLANGE FEMALE FITTING
- REUSEABLE 90° FEMALE FITTING
- REUSEABLE 90° FLANGE FEMALE FITTING
- REUSEABLE STRAIGHT FLANGE FEMALE FITTING
- SPLICER STRAIGHT SERVICE O-RING
- STRAIGHT FEMALE O-RING step up - step down
- STRAIGHT FEMALE O-RING
- STRAIGHT MALE O-RING INSERT
- STRAIGHT MALE O-RING step up - step down
- STRAIGHT MALE O-RING
- STRAIGHT SERVICE FEMALE O-RING
- STRAIGHT SERVICE MALE O-RING

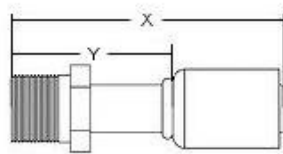
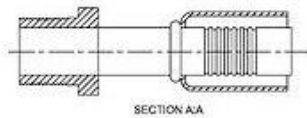

Hose beadlock fitting, straight male fitting for hose connections. Insert.

Type: Straight male O-ring insert

Application: Air conditioning

Material: -

Fitting size: #6

Hose size: 5/16

Thread: 5/8 18 UNF

Type No	Fittings size	Hose size	Thread	X	Y	Z	Weight
525006138	#12	5/8	1 1/16 14 UNF	0	0	0	0
525006137	#10	1/2	7/8 14 UNF	0	0	0	0
525006136	#8	13/32	3/4 16 UNF	0	0	0	0
525006135	#6	5/16	5/8 18 UNF	0	0	0	0

Codan Straight male O-ring step up - step down

- 45° FEMALE O-RING step up - step down
- 45° FEMALE O-RING
- 45° FEMALE SERVICE O-RING
- 45° MALE O-RING INSERT
- 45° MALE O-RING step up - step down
- 45° MALE O-RING
- 90° FEMALE O-RING step up - step down
- 90° FEMALE O-RING
- 90° FEMALE SERVICE O-RING
- 90° FEMALE SHORT O-RING
- 90° MALE O-RING INSERT
- 90° MALE O-RING step up - step down
- 90° MALE O-RING
- 180° FEMALE O-RING
- REUSEABLE 45° FLANGE FEMALE FITTING
- REUSEABLE 90° FEMALE FITTING
- REUSEABLE 90° FLANGE FEMALE FITTING
- REUSEABLE STRAIGHT FLANGE FEMALE FITTING
- SPLICER STRAIGHT SERVICE O-RING
- STRAIGHT FEMALE O-RING step up - step down
- STRAIGHT FEMALE O-RING
- STRAIGHT MALE O-RING INSERT
- STRAIGHT MALE O-RING step up - step down
- STRAIGHT MALE O-RING
- STRAIGHT SERVICE FEMALE O-RING
- STRAIGHT SERVICE MALE O-RING

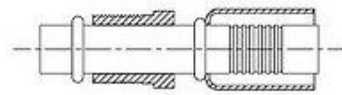

SECTION A-A

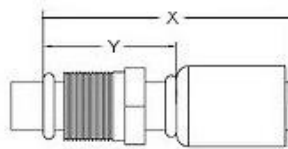

Type: Straight male O-ring step up - step down

Application: Air conditioning

Material: -

Fitting size: #12

Hose size: 5/8

Thread: 7/8- 18 UNF

Type No	Fittings size	Hose size	Thread	X	Y	Z	Weight
525006128	#12	5/8	7/8- 18 UNF	116	58	0	0
525006129	#6	5/16	3/4 - 18 UNF	96	35	0	0
525006127	#8	13/32	5/8- 18 UNF	96	35	0	0

This hose specification sheet has been prepared with great care in order to provide you with all the information you need. Written advice must be obtained from Codan Rubber before using any hose with untested media or before using in applications not covered in the product data sheet. Codan Rubber recommends regular maintenance, care and inspection of hoses before use. Hoses should be replaced if any physical damage is seen, especially to the cover of the hose or in the area around the couplings. All products must be stored in accordance with ISO 2230:2002 (Storage of vulcanised Rubber Products).

The individual conditions of an application will affect the life time of each product. Therefore please ensure that resistance to chemicals and cleaning procedures in our written product information is complied with. Codan Rubber's warranty is void in the event of misuse such as excessive bending, crushing, stretching, use with incorrect media or use in environments outside the hose specification.

Please contact Codan Rubber for individual product manufacturing tolerances.

Codan Straight Male O-ring

- 45° FEMALE O-RING step up - step down
- 45° FEMALE O-RING
- 45° FEMALE SERVICE O-RING
- 45° MALE O-RING INSERT
- 45° MALE O-RING step up - step down
- 45° MALE O-RING
- 90° FEMALE O-RING step up - step down
- 90° FEMALE O-RING
- 90° FEMALE SERVICE O-RING
- 90° FEMALE SHORT O-RING
- 90° MALE O-RING INSERT
- 90° MALE O-RING step up - step down
- 90° MALE O-RING
- 180° FEMALE O-RING
- REUSEABLE 45° FLANGE FEMALE FITTING
- REUSEABLE 90° FEMALE FITTING
- REUSEABLE 90° FLANGE FEMALE FITTING
- REUSEABLE STRAIGHT FLANGE FEMALE FITTING
- SPLICER STRAIGHT SERVICE O-RING
- STRAIGHT FEMALE O-RING step up - step down
- STRAIGHT FEMALE O-RING
- STRAIGHT MALE O-RING INSERT
- STRAIGHT MALE O-RING step up - step down
- STRAIGHT MALE O-RING
- STRAIGHT SERVICE FEMALE O-RING
- STRAIGHT SERVICE MALE O-RING

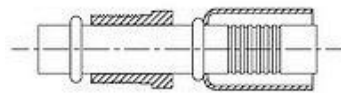

SECTION A-A

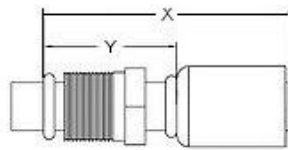

Hose beadlock fitting, straight male fitting for hose connections.

Type: Straight Male O-ring
Application: Air conditioning
Material: -
Fitting size: #6
Hose size: 5/16
Thread: 5/8 18UNF

Type No	Fittings size	Hose size	Thread	X	Y	Z	Weight
525006095	#10	1/2	7/8 - 18UNF	91	40	0	0
525006094	#8	13/32	3/4 - 18UNF	88	35	0	0
525006093	#6	5/16	5/8 18UNF	81	35	0	0
525006096	#12	5/8	1 1/16 18UNF	98	40	0	0

This hose specification sheet has been prepared with great care in order to provide you with all the information you need. Written advice must be obtained from Codan Rubber before using any hose with untested media or before using in applications not covered in the product data sheet. Codan Rubber recommends regular maintenance, care and inspection of hoses before use. Hoses should be replaced if any physical damage is seen, especially to the cover of the hose or in the area around the couplings. All products must be stored in accordance with ISO 2230:2002 (Storage of vulcanised Rubber Products).

The individual conditions of an application will affect the life time of each product. Therefore please ensure that resistance to chemicals and cleaning procedures in our written product information is complied with. Codan Rubber's warranty is void in the event of misuse such as excessive bending, crushing, stretching, use with incorrect media or use in environments outside the hose specification.

Please contact Codan Rubber for individual product manufacturing tolerances.

Codan Straight service female O-ring

- 45° FEMALE O-RING step up - step down
- 45° FEMALE O-RING
- 45° FEMALE SERVICE O-RING
- 45° MALE O-RING INSERT
- 45° MALE O-RING step up - step down
- 45° MALE O-RING
- 90° FEMALE O-RING step up - step down
- 90° FEMALE O-RING
- 90° FEMALE SERVICE O-RING
- 90° FEMALE SHORT O-RING
- 90° MALE O-RING INSERT
- 90° MALE O-RING step up - step down
- 90° MALE O-RING
- 180° FEMALE O-RING
- REUSEABLE 45° FLANGE FEMALE FITTING
- REUSEABLE 90° FEMALE FITTING
- REUSEABLE 90° FLANGE FEMALE FITTING
- REUSEABLE STRAIGHT FLANGE FEMALE FITTING
- SPLICER STRAIGHT SERVICE O-RING
- STRAIGHT FEMALE O-RING step up - step down
- STRAIGHT FEMALE O-RING
- STRAIGHT MALE O-RING INSERT
- STRAIGHT MALE O-RING step up - step down
- STRAIGHT MALE O-RING
- STRAIGHT SERVICE FEMALE O-RING
- STRAIGHT SERVICE MALE O-RING

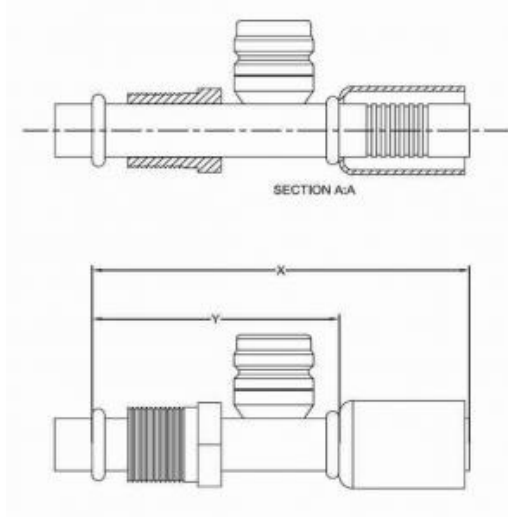

Hose beadlock fitting, straight service female fitting for hose connections.

Type: Straight service female O-ring
Application: Air conditioning
Material: -
Fitting size: #8
Hose size: 13/32
Thread: 3/4 - 16 UNF

Type No	Fittings size	Hose size	Thread	X	Y	Z	Weight
525006073	#6	5/16	5/8 - 18UNF	81	35	0	0
525006074	#8	13/32	3/4 - 16 UNF	88	35	0	0
525006075	#10	1/2	7/8 - 14 UNF	91	40	0	0
525006076	#12	5/8	1 1/16 - 14 UNF	98	40		

This hose specification sheet has been prepared with great care in order to provide you with all the information you need. Written advice must be obtained from Codan Rubber before using any hose with untested media or before using in applications not covered in the product data sheet. Codan Rubber recommends regular maintenance, care and inspection of hoses before use. Hoses should be replaced if any physical damage is seen, especially to the cover of the hose or in the area around the couplings. All products must be stored in accordance with ISO 2230:2002 (Storage of vulcanised Rubber Products).

The individual conditions of an application will affect the life time of each product. Therefore please ensure that resistance to chemicals and cleaning procedures in our written product information is complied with. Codan Rubber's warranty is void in the event of misuse such as excessive bending, crushing, stretching, use with incorrect media or use in environments outside the hose specification.

Please contact Codan Rubber for individual product manufacturing tolerances.

Codan Straight service male O-ring

- 45° FEMALE O-RING step up - step down
- 45° FEMALE O-RING
- 45° FEMALE SERVICE O-RING
- 45° MALE O-RING INSERT
- 45° MALE O-RING step up - step down
- 45° MALE O-RING
- 90° FEMALE O-RING step up - step down
- 90° FEMALE O-RING
- 90° FEMALE SERVICE O-RING
- 90° FEMALE SHORT O-RING
- 90° MALE O-RING INSERT
- 90° MALE O-RING step up - step down
- 90° MALE O-RING
- 180° FEMALE O-RING
- REUSEABLE 45° FLANGE FEMALE FITTING
- REUSEABLE 90° FEMALE FITTING
- REUSEABLE 90° FLANGE FEMALE FITTING
- REUSEABLE STRAIGHT FLANGE FEMALE FITTING
- SPLICER STRAIGHT SERVICE O-RING
- STRAIGHT FEMALE O-RING step up - step down
- STRAIGHT FEMALE O-RING
- STRAIGHT MALE O-RING INSERT
- STRAIGHT MALE O-RING step up - step down
- STRAIGHT MALE O-RING
- STRAIGHT SERVICE FEMALE O-RING
- STRAIGHT SERVICE MALE O-RING

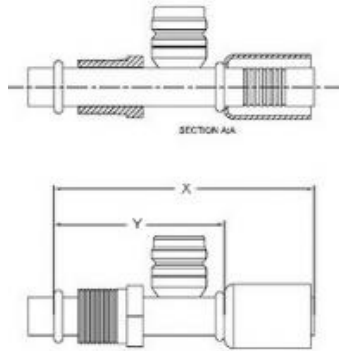

Hose beadlock fitting, straight service female fitting for hose connections.

Type: Straight service male O-ring

Application: Air conditioning

Material: -

Fitting size: #12

Hose size: 5/8

Thread: 1 1/16 - 14 unf

Type No	Fittings size	Hose size	Thread	X	Y	Z	Weight
525006097	#6	5/16	5/8 - 18UNF	0	0	0	0
525006098	#8	13/32	3/4 - 18UNF	0	0	0	0
525006099	#10	1/2	7/8-14 unf	0	0	0	0
525006100	#12	5/8	1 1/16 - 14 unf	0	0	0	0

This hose specification sheet has been prepared with great care in order to provide you with all the information you need. Written advice must be obtained from Codan Rubber before using any hose with untested media or before using in applications not covered in the product data sheet. Codan Rubber recommends regular maintenance, care and inspection of hoses before use. Hoses should be replaced if any physical damage is seen, especially to the cover of the hose or in the area around the couplings. All products must be stored in accordance with ISO 2230:2002 (Storage of vulcanised Rubber Products).

The individual conditions of an application will affect the life time of each product. Therefore please ensure that resistance to chemicals and cleaning procedures in our written product information is complied with. Codan Rubber's warranty is void in the event of misuse such as excessive bending, crushing, stretching, use with incorrect media or use in environments outside the hose specification.

Please contact Codan Rubber for individual product manufacturing tolerances.